

Protecting your Screen:

To ensure long lasting viewing enjoyment keep the screen rolled up when not in use. Check both the front and back surfaces before retracting into the case to make sure it is free of dust, dirt, insects or other foreign matter. Use a soft brush or cloth to lightly remove any foreign particles.

Cleaning your Screen:

Use warm water with a mild detergent to remove any marks on the surface (only dab, do not rub) or screen casing. Immediately dry the screen with a soft cloth or towel. Do not leave it to air dry.

Never use any solvents, chemicals or abrasive cleaners on the screen surface as they can permanently damage the screen surface.

Note: Warranty does not cover un-installing or re-installing unit.

gv

GRANDVIEW®

Imported and Distributed in Australia by
Herma Technologies
Factory 4A, 6 Albert St
Preston, VIC 3072

For more information please go to
www.grandviewscreens.com.au
or call 1300 730 025

gv

GRANDVIEW®

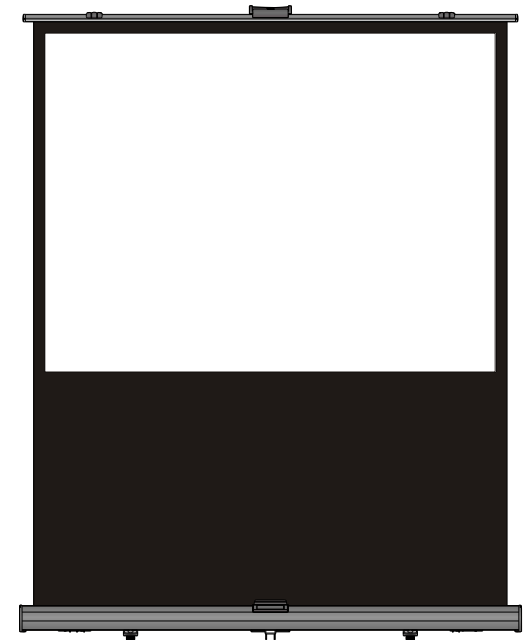

Grandview Pull Up
Portable Screen
User Manual

To the owner

Congratulations on purchasing a **Grandview Portable Screen**, designed to produce the sharpest, most pleasing pictures with maximum convenience.

Assembling the screen

Lie the screen flat on the floor and swing out the feet so that they are perpendicular to the casing.

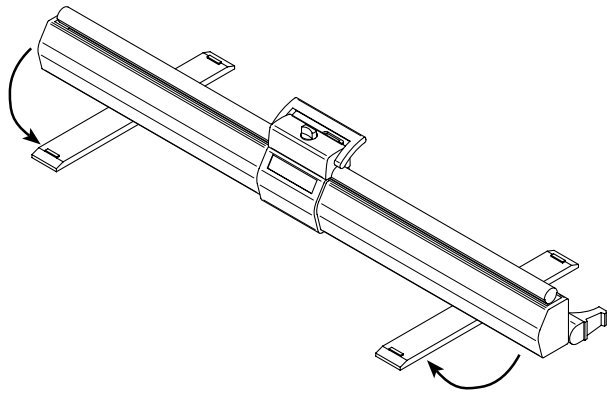

Release the handle

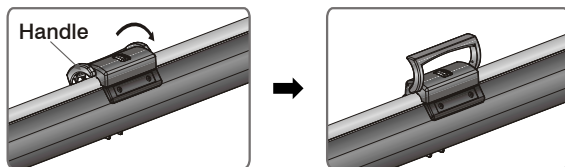

Pull the handle, releasing the lock and stop at the desired height.

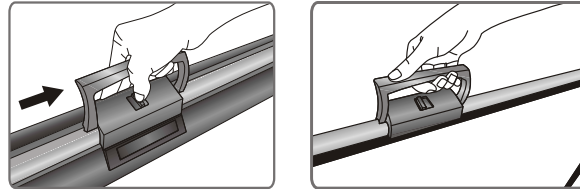

Pull the screen up and stop at the desired position.

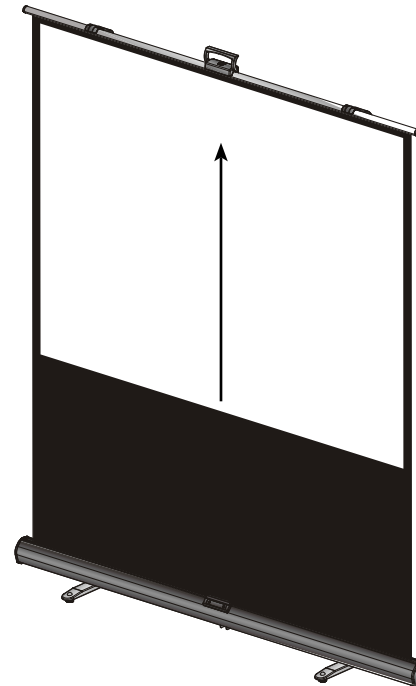

Packing the screen away

Hold the handle and slowly retract the screen into the casing. Snap the handle into the base.

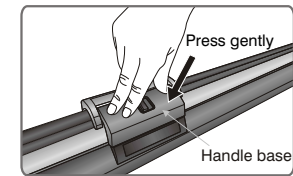
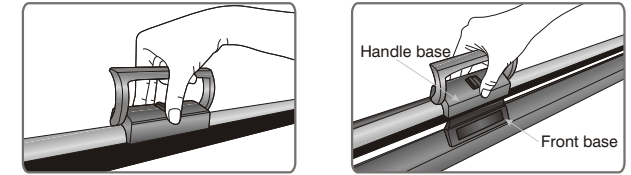

Fold away the feet in line with the casing. Retraction is complete.

